



2021 EXHIBITOR FACT SHEET

HUNTINGTON CONVENTION CENTER | CLEVELAND, OHIO
CONFERENCE: NOVEMBER 8, 2021
EXPO HALL: NOVEMBER 9-10, 2021

Fastener Fair USA is the only exhibition in the U.S. dedicated to the full supply chain—distributors, mechanical and design engineers, purchasers, wholesalers, and OEMs. From automotive to aerospace, construction to HVAC, furniture to appliances, fastener professionals from every segment of the market find the latest products they need at Fastener Fair USA

VISITOR STATS

79%

OF ATTENDEES HAVE
INPUT INTO
DECISION-MAKING

90%

OF ATTENDEES WERE
SATISFIED WITH
FASTENER FAIR 2019

82%

OF ATTENDEES CONSIDER
FASTENER FAIR USA
IMPORTANT TO ATTEND

TOP REASONS ATTENDEES VISITED



NETWORK WITH
INDUSTRY COLLEAGUES



FIND NEW PRODUCTS OR
BUSINESS SOLUTIONS



MAKE NEW CONTACT



ATTENDEE JOB TITLES/ RESPONSIBILITIES

22%

BUYER/PURCHASE/PROCURER

18%

DEPARTMENT HEAD/
SENIOR MANAGER

18%

ENGINEER/TECHNICAL SPECIALIST

15%

MANAGING DIRECTOR/BOARD
MEMBER/HEAD OF AN AUTHORITY

11%

ENTREPRENEUR/PARTNERS/
CONSULTANT/ADVISOR

INDUSTRIES REPRESENTED

- AEROSPACE
- AUTOMOTIVE
- AGRICULTURE/ OFF-HIGHWAY MACHINERY
- INDUSTRIAL MACHINERY

- DISTRIBUTION
- CONSTRUCTION
- ELECTRONICS
- ENERGY
- ELECTRICAL PRODUCTS

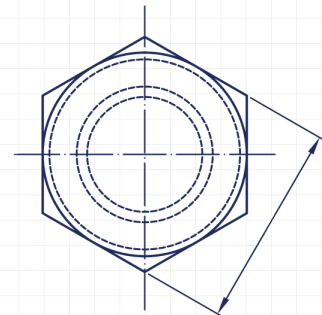

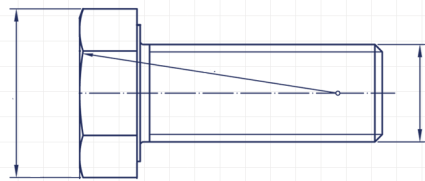

TOP 3 REASONS EXHIBITOR PARTICIPATE AT FASTENER FAIR USA

INCREASE OVERALL BRAND PERCEPTION 

BUILD RELATIONSHIPS AND MEET NEW CUSTOMERS 

LAUNCH A NEW PRODUCT 

ACCESS TO Connector365

Powered By Fastener Fair USA

YEAR-ROUND ONLINE PLATFORM FEATURING THOUGHT LEADERSHIP AND INDUSTRY EXPERTISE. THIS IS YOUR CHANCE TO EXTEND YOUR BRAND BEYOND FASTENER FAIR USA. YOU GAIN ACCESS TO:

1:1 ABILITY TO SET 1:1 MEETINGS NEARLY YEAR-ROUND WITH THE ENTIRE FASTENER FAIR USA DATABASE.

 YOU'LL BE RECOMMENDED TO KEY DECISION MAKERS IN THE INDUSTRY BEYOND A PHYSICAL EVENT.

INDUSTRY PARTNERS



FASTENER TRAINING INSTITUTE



WHAT OUR VENDORS ARE SAYING

“ This event is a good collection and cross section of other industries and industry segments...Fastener Fair USA has given us the opportunity to make contacts and start developing new relationships. ”

- DOERKEN CORPORATION USA

FASTENER FAIR USA HEADS BACK TO CLEVELAND



CLEVELAND, OHIO IS A LEADER IN U.S. MANUFACTURING JOBS*.



CLEVELAND HAS A **\$236 BILLION ANNUAL ECONOMY** AND IS HOME TO A NUMBER OF COMPANIES THAT ARE ON **FORTUNE MAGAZINE'S LIST OF THE TOP 500 INDUSTRY AND TOP 500 SERVICE COMPANIES** IN THE UNITED STATES**.





NEARLY 50% OF THE U.S. POPULATION IS LOCATED WITHIN 500 MILES OF CLEVELAND, WHICH MEAN DRIVING IS AN OPTION **

*2017 OHIO MANUFACTURING COUNTS IMPACT REPORT

**CLEVELAND CONVENTION AND VISITORS BUREAU AND CLEVELAND OFFICIAL VISITORS GUIDE

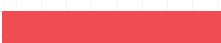

VISITOR ROLES IN THE INDUSTRY

MANUFACTURER	40%	
DISTRIBUTOR/END-USED SUPPLIER	41%	
FASTENER END-USER	11%	
WHOLESALES/RESELLER SUPPLIER	8%	



HUNTINGTON CONVENTION CENTER CLEVELAND, OHIO

CONFERENCE: NOVEMBER 8, 2021
EXPO HALL: NOVEMBER 9-10, 2021

INTERESTED IN EXHIBITING? FOR PREMIUM BOOTH SPACE AND SPONSORSHIPS FOR 2021, CONTACT:
RAYMOND FILBERT, SALES MANAGER
rfilbert@reedexpo.com, +1 (203) 840-5821
FASTENERFAIRUSA.COM